



NuPower Xtender™ LS20S01-D19 L- & S-Band Bidirectional Amplifier

25 Watt CW
1.0 GHz - 2.5 GHz

P/N: NW-BA-LS-20-S01-D19

Contact sales@nuwaves.com for custom options



The NuPower Xtender™ LS20S01-D19 is a small, lightweight, and power-efficient bidirectional amplifier ideal for extending the communication range of half-duplex L- or S-band transceivers. The bidirectional amplifier typically generates 25 Watts of RF power from 1000 to 2500 MHz in transmit mode and the integrated low-noise amplifier typically provides 14 dB of gain in receive mode.

Based on the latest gallium nitride (GaN) technology, the Xtender typically offers 39% power efficiency at most frequencies and its compact size makes it ideal for integration into space-constrained platforms. Adjacent radio frequency bands, such as the popular 900 MHz Industrial, Scientific and Medical (ISM) band, are also supported by the bidirectional PA, at lower peak power levels.

Accepting a nominal +19 dBm RF input, the Xtender typically provides 25 dB of power gain. The Xtender also features over-voltage and reverse-voltage protection and operates over a wide temperature range of -40 to +85 °C baseplate.

Extend your operational communication range with NuPower™ amplifiers from NuWaves RF Solutions.

Features

- 25 Watts (typ) RF Output Power
- 1.0 to 2.5 GHz
- Bidirectional Operation
- 25 dB (typ) of Transmit Power Gain
- 14 dB (typ) Receive Gain
- Fast T/R Mode Switching with Auto-Sensing or Manual T/R Line
- Small Form Factor
- High Efficiency GaN Technology
- Over-Voltage & Reverse-Voltage Protection

Applications

- Unmanned Aircraft Systems (UAS) - Group 2 and Group 3
- Unmanned Ground Vehicles (UGV)
- Software Defined Radios
- Air Launch Effect (ALE)
- Common Launch Tube (CLT)
- Counter UAS Detection and Mitigation
- MIMO/MANET Radio Range Extension
- SISO Radio Range Extension

NuPower Xtender™ LS20S01-D19 BDA

Specifications

Absolute Maximums

Parameter	Rating	Unit
Max Device Voltage	32	V
Max Device Current	3.5	A
Max RF Input Power, CW, $Z_L = 50 \Omega$	XCVR Port ¹ : +33	dBm
	ANT Port ² : +30	
Max Operating Temperature (ambient)	60	°C
Max Operating Temperature (baseplate)	85	°C
Max Storage Temperature	85	°C

Export Classification
EAR99

¹Max operational XCVR input power +22dBm

²Max operational receive input power = -20 dBm (Autosense Mode only)

Electrical Specifications - Operational @ 28 VDC, 25 °C, $Z_S=Z_L=50 \Omega$, CW, Pin = + 19 dBm (unless otherwise specified)

Parameter	Symbol	Min	Typ	Max	Unit	Condition
Operating Frequency	BW	1000		2500	MHz	
Switching Speed	TX _{ON/OFF}		0.95	1.5	μ S	Rx - Tx (Manual T/R)
			1.3	1.5		Tx - Rx (Manual T/R)
			1.3	1.5		Rx - Tx (Autosense)
			1.6	2.0		Tx - Rx (Autosense)
Operating Voltage	VDC	11	28	32	V	
Operating Current (Transmit)	I _{DD}		2.3	3.5	A	
Module Efficiency (Transmit)			39		%	

Electrical Specifications - Transmit @ 28 VDC, 25 °C, $Z_S=Z_L=50 \Omega$, CW, Pin = +19 dBm (unless otherwise specified)

Parameter	Symbol	Min	Typ	Max	Unit	Condition
RF Output Power, Psat	Psat	15	25		W	
Transmit Gain	G		25		dB	
Power Gain Flatness	Δ G		\pm 1		dB	1-2.5 GHz
Small Signal Gain	G		32			Pin=-20 dBm, 1-2.5 GHz
Small Signal Gain Flatness	Δ G		\pm 3		dB	Pin= -20 dBm, 1-2.5 GHz
Harmonics	2nd		TBD		dBc	
	3rd		TBD			
Nominal Input Drive Level	P _{IN}		19	22	dBm	
Quiescent Current	I _{DQ}		75		mA	T/R Enable Off (Receive Current)
Transmit Current	I _{TX}		2.3	3.5	A	
Transmit Input VSWR (XCVR Port)	VSWR		1.3:1			
Transmit Output Mismatch VSWR	VSWR			10:1	Ψ	No damage at all phase angles

Electrical Specifications - Receive @ 28 VDC, 25 °C, $Z_S=Z_L=50 \Omega$, CW, -30 dBm Input Power (unless otherwise specified)

Parameter	Symbol	Min	Typ	Max	Unit	Condition
Receive Gain	G	12	14		dB	
Receive P1dB	P1dB		16		dBm	Pin=+3 dBm (typ)
Receive Gain Flatness	Δ G		\pm 1		dB	1-2.5 GHz

NuPower Xtender™ LS20S01-D19 BDA

Specifications (cont.)

Electrical Specifications - Receive (cont.) @ 28 VDC, 25 °C, $Z_S=Z_L=50 \Omega$, CW, -30 dBm Input Power (unless otherwise specified)

Parameter	Symbol	Min	Typ	Max	Unit	Condition
Receive Current	I_{RX}		75		mA	
Receive Noise Figure	NF		2.1		dB	
Receive Input VSWR (ANT Port)	VSWR		1.6:1			

Mechanical Specifications

Parameter	Value	Unit	Limits
Dimensions	3.0 x 2.0 x 0.65	in	Max
Weight	4	oz	Max
RF Connectors, Input/Output	SMA Female		
Interface Connector	Micro-D, 9-pin Socket		
Cooling	Adequate Heatsink Required		

Environmental Specifications

Parameter	Symbol	Min	Typ	Max	Unit
Operating Temperature (ambient)	T_A	-40		+60	°C
Operating Temperature (baseplate)	T_C	-40		+85	°C
Storage Temperature	T_{STG}	-55		+85	°C
Relative Humidity (non-condensing)	RH			95	%
Altitude MIL-STD-810F - Method 500.4	ALT			30,000	ft
Vibration / Shock Profile (Random profile in x,y, z axis, as per Figure for 15 minute duration in each axis)					

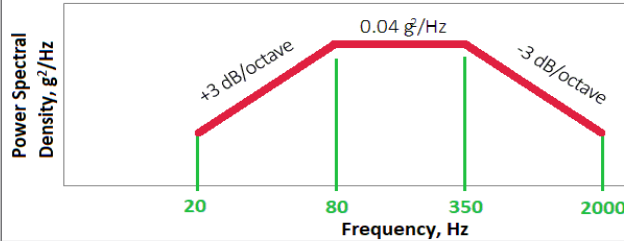

Transmit Performance Plots

Test Conditions: +28 VDC, +25 °C, $Z_S=Z_L=50 \Omega$, CW, +19 dBm Input Power (unless otherwise specified)

Output Power

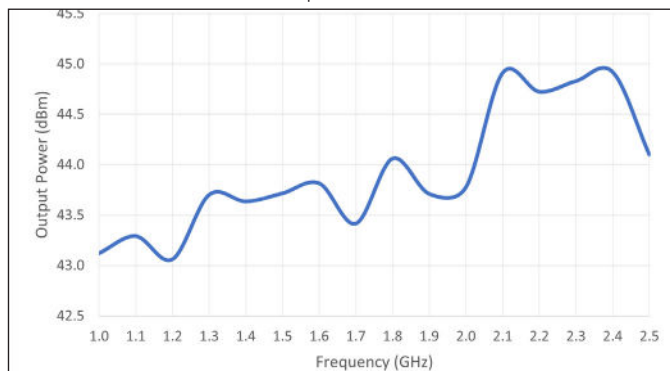

Output Power - Stepped Input Power

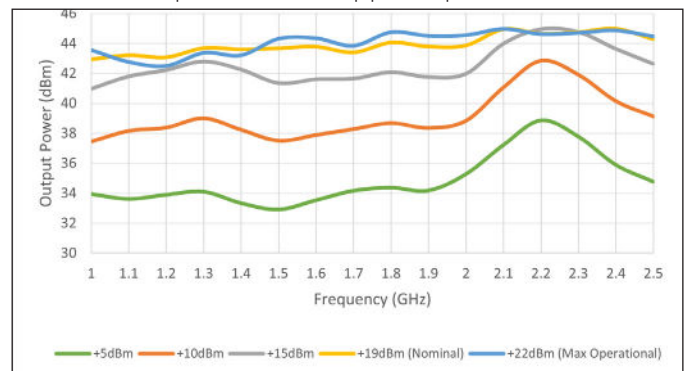

NuPower Xtender™ LS20S01-D19 BDA

Transmit Performance Plots (cont.)

Test Conditions: +28 VDC, +25 °C, $Z_S=Z_L=50 \Omega$, CW, +19 dBm Input Power (unless otherwise specified)

Output Power vs. Input Power

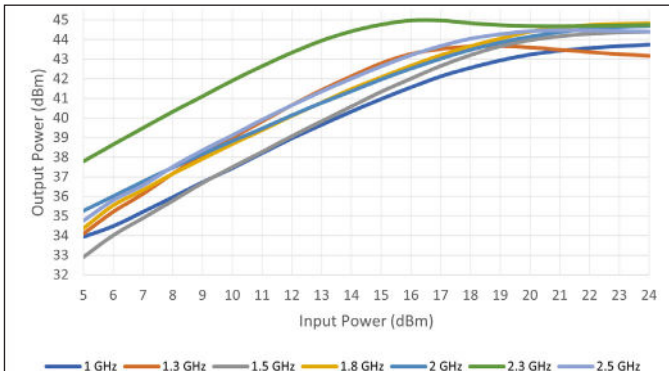

Output Power vs. Input Voltage

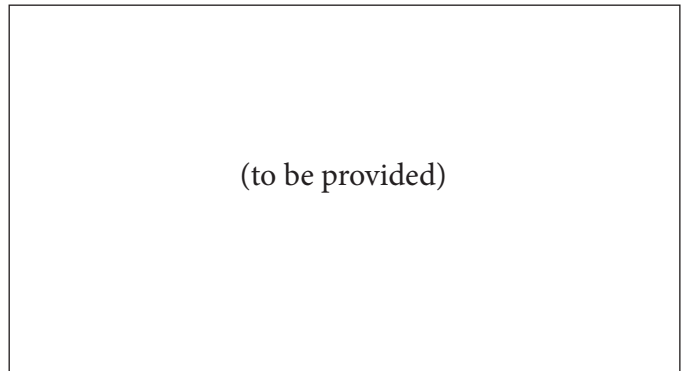

Current Consumption

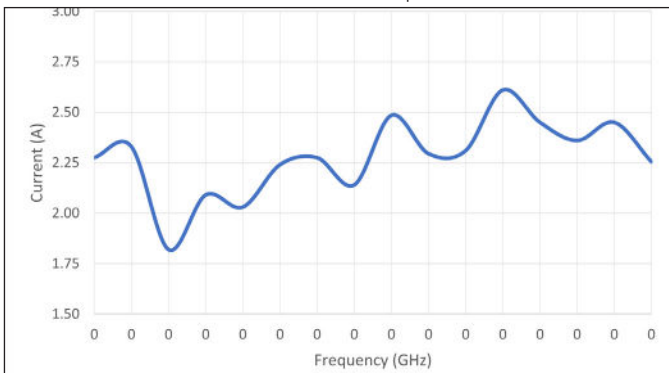

Transmit Small Signal Gain [-20 dBm Input Power]

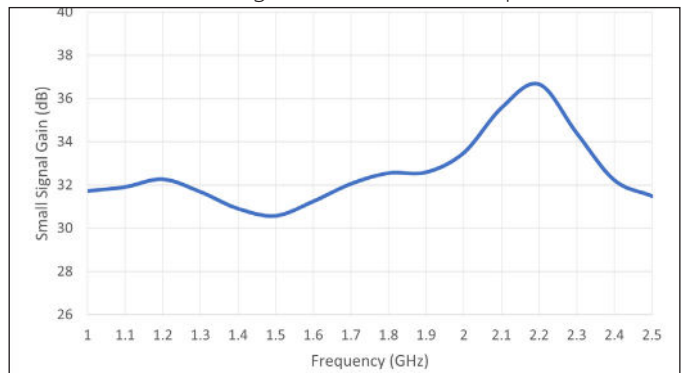

Efficiency

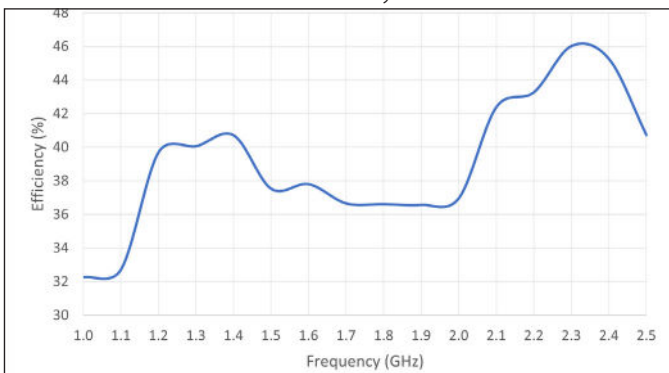

Efficiency vs. Output Power

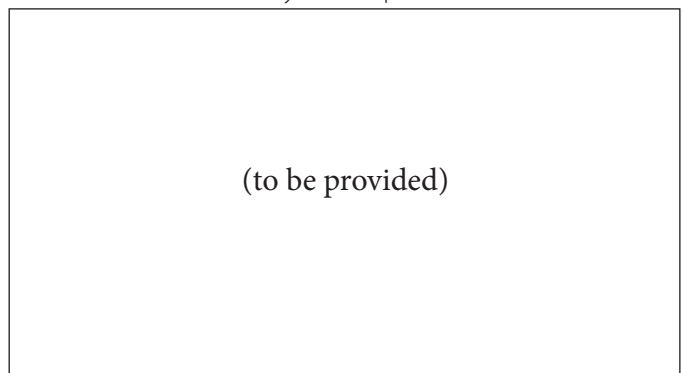

Transmit Input VSWR

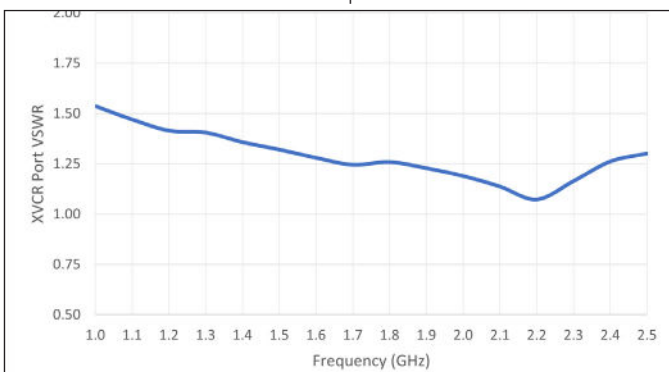

Harmonics

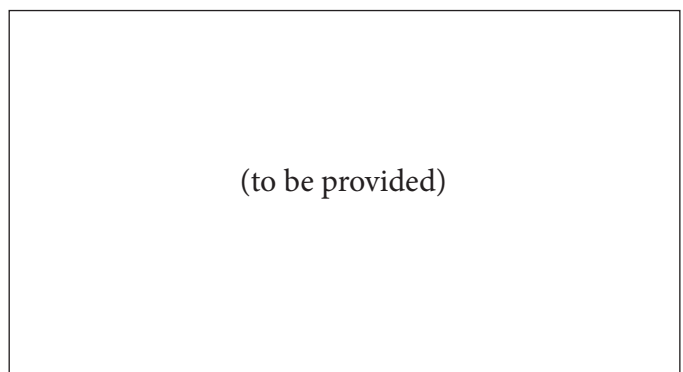

NuPower Xtender™ LS20S01-D19 BDA

Transmit Performance Plots (cont.)

Test Conditions: +28 VDC, +25 °C, $Z_s=Z_L=50 \Omega$, CW, +19 dBm Input Power (unless otherwise specified)

Transmit P1dB & P3dB

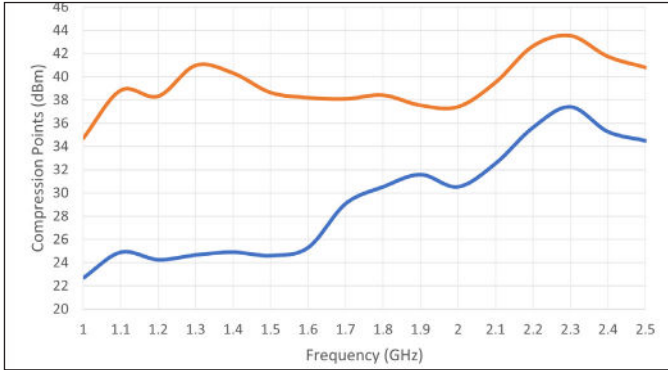

EVM vs. Output Power [QPSK, 1 Msps, 35% Filter]

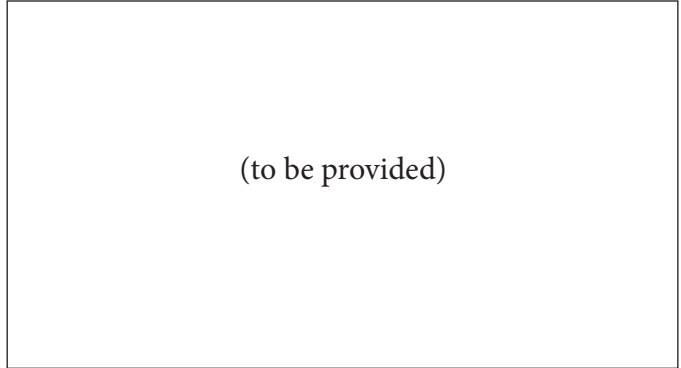

EVM vs. Output Power [16 QAM, 2 Msps, 35% Filter]

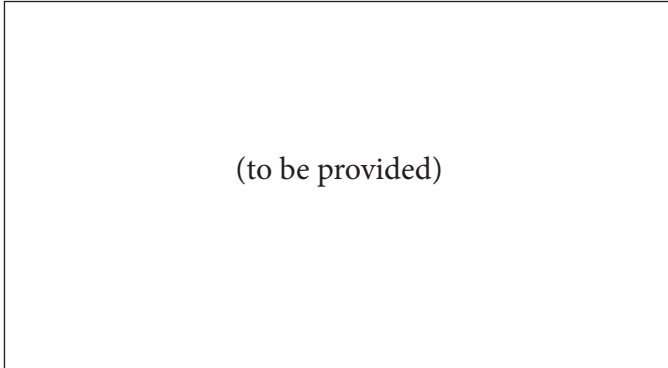

EVM vs. Output Power [64 QAM, 5 Msps, 10% Filter]

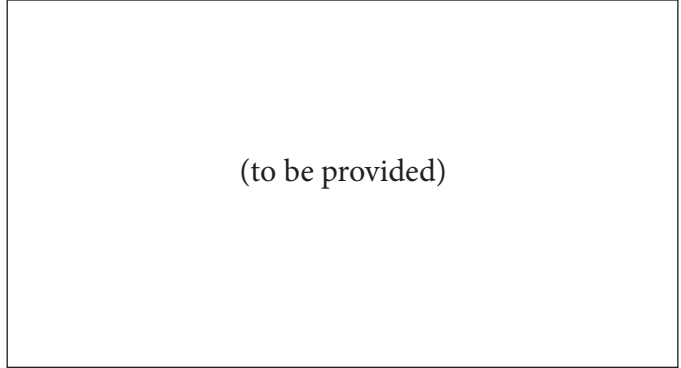

NuPower Xtender™ LS20S01-D19 BDA

Receive Performance Plots

Test Conditions: +28 VDC, +25 °C, $Z_s=Z_L=50 \Omega$, CW, -30 dBm Input Power (unless otherwise specified)

Receive Gain

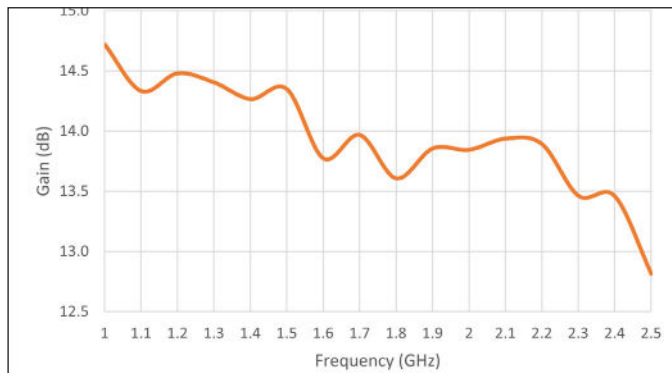

Receive Gain vs Temperature

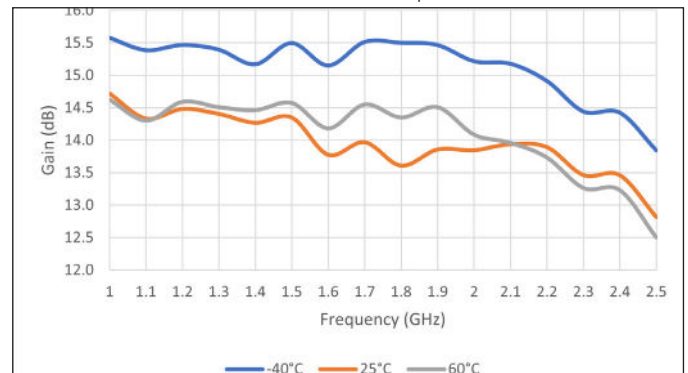

Receive P1dB

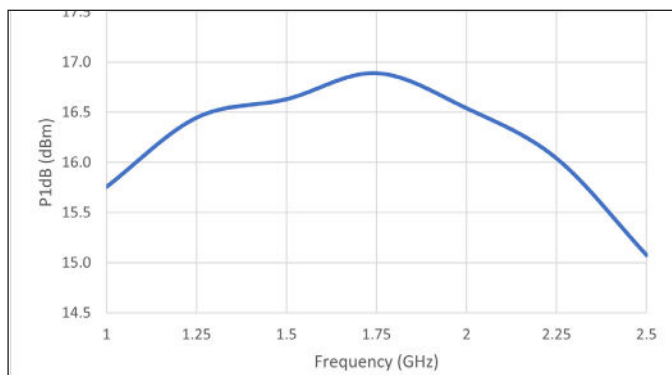

Receive Noise Figure

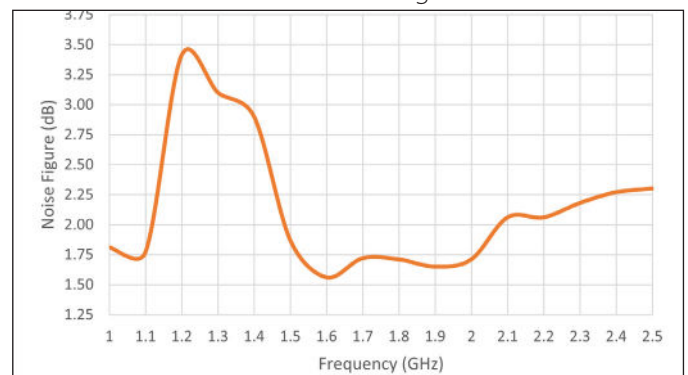

Receive Noise Figure vs Temperature

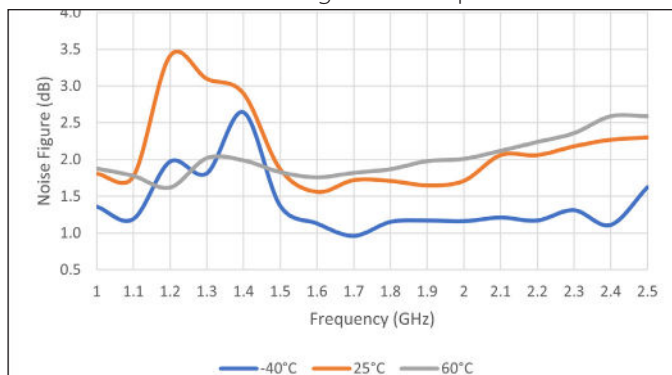

Receive Input VSWR

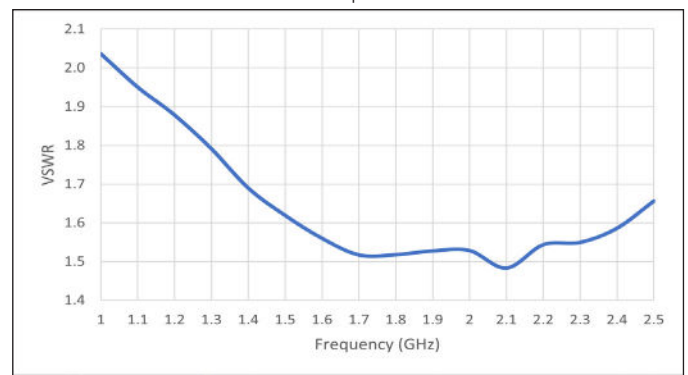

NuPower Xtender™ LS20S01-D19 BDA

Mechanical Outline

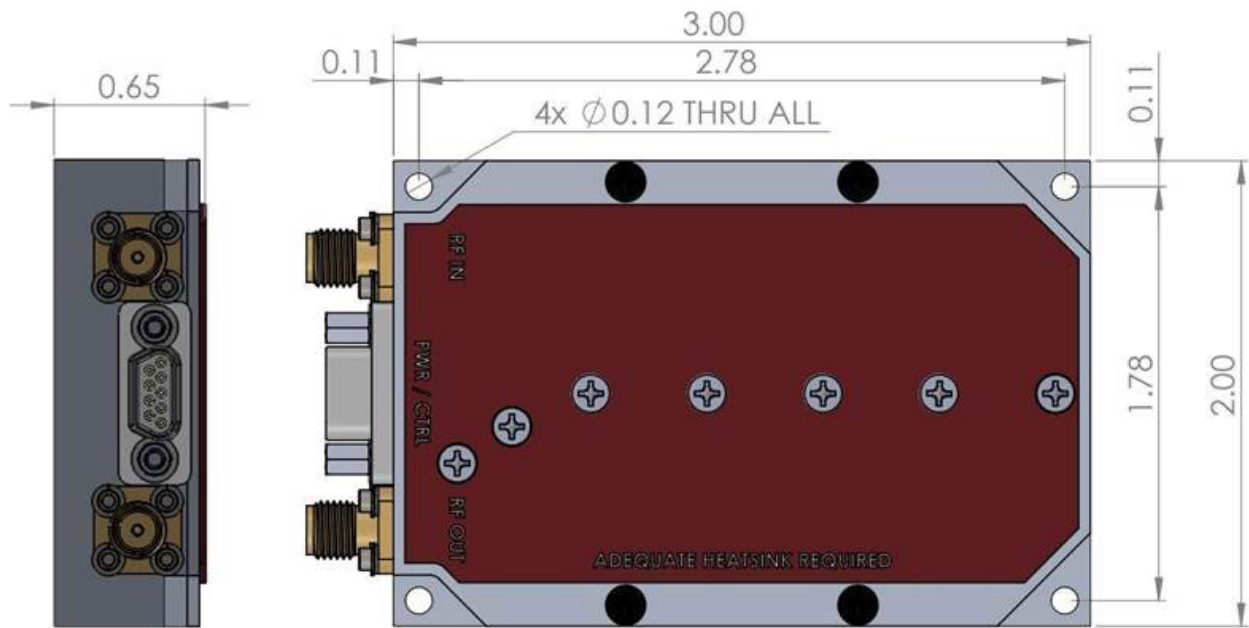

NuPower Xtender™ LS20S01-D19 BDA

Optional Heatsink Drawing

Heatsink and Integrated Fan: HTSK-01

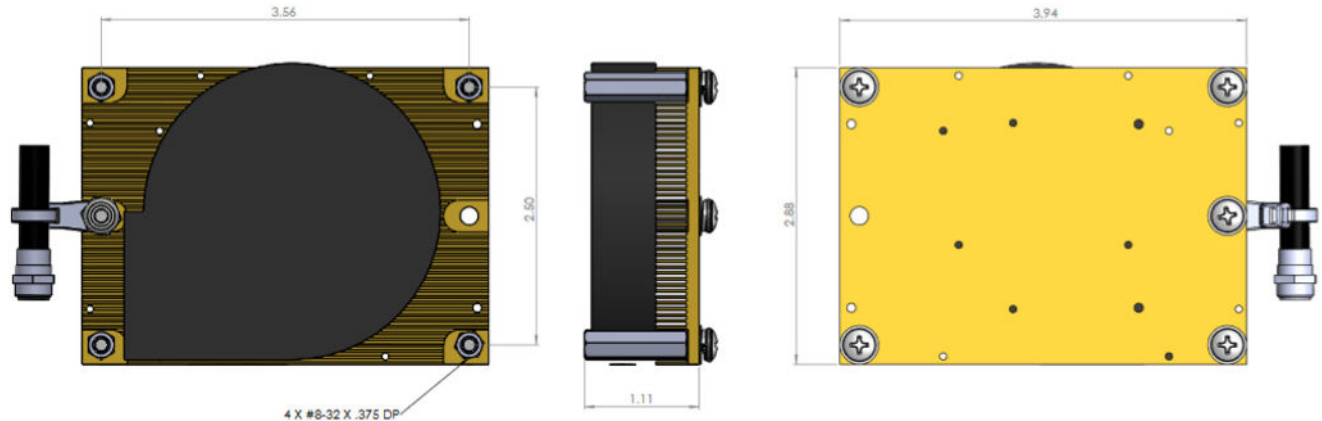

Accessory Part Numbers - Sold Separately

Part Number	Description
NW-FL-05LPLE-2500-SFSF-M01	Harmonic Filter Module
NW-BA-ACC-CB09MA	Standard Interface Cable Assembly - Flying Leads
NW-BA-ACC-CT09MA	Upgraded Interface Cable Assembly - Banana Plug Termination
HTSK-01	Heatsink with Integrated Fan

For information on product disposal (end-of-life), please refer to this document:
<https://nuwaves.com/wp-content/uploads/Product-Disposal-End-of-Life.pdf>

Pinout

Function	I/O	Pin	Logic Voltage
DC Power (Primary Power, +11 to +32 Volts)	I	1, 2, 9	-
Ground (DC Return)	I	3, 4, 5	-
RS-485 Data Transmit	O	6	-
RS-485 Data Receive	I	7	-
T/R Enable			3.3V Logic ² High: 2.31 - 3.8 VDC Low: -0.5 - 0.99 VDC
T/R Mode: Source (Autosense) ¹ T/R Mode: Sink (Manual T/R) ³ [High TX / Low RX]	I/O	8	5V Logic ² High: 3.5 - 5.5 VDC Low: -0.5 - 1.5 VDC

¹Autosense automatically switches to transmit and receive based on input signal strength. Typical threshold is 0 dBm; see user manual for complete information.

²Logic level configurable by user or factory. Default logic level is 3.3V.

³Default T/R mode is Manual (sink) mode.

Contact NuWaves



NuWaves RF Solutions
 132 Edison Drive
 Middletown, OH 45044

www.nuwaves.com
sales@nuwaves.com
 513.360.0800

